

plus-ton®

Listino prezzi Price list

2019/20

360°

plus+ton[®]



Da un'unica fusione ad altissime temperature di **1.250°**, prende vita un materiale ceramico, qualificato come **totalmente riciclabile** e quindi **100% ecologico**, derivato da un ciclo produttivo privo di emissioni inquinanti in atmosfera.

plus+ton è una superficie ceramica completamente **anti-graffio, anti-macchia, anti-scivolo, anti-batterica** e sostituisce facilmente quei prodotti realizzati con resine, solventi e catalizzatori, materiali altamente inquinanti e non riciclabili.

plus+ton utilizza esclusivamente **materie prime naturali** di altissima qualità con la sola aggiunta di **acqua e fuoco**.



CERTIFIED 100% MADE IN ITALY



INDUSTRIAL INVENTION
PATENT No. AN2014A000135



From one single fusion at very high temperatures of **1.250°**, comes to life a ceramic material **qualified as entirely recyclable** and therefore **100% eco-friendly**, derived from a productive cycle with no pollutant emissions into the atmosphere.

plus+**ton** is a ceramic surface completely **scratch-proof, stain-proof, slip-proof, as well as bacterial resistant** and can easily replace those products manufactured using resins, solvents and catalysts; materials that are highly pollutant and non-recyclable.

plus+**ton** uses only **natural raw materials** of the highest quality by just adding **water and fire**.



plus-ton®

Indice / Index

Piatti doccia Plus / Plus Showers Trays	- 6
Taglio su misura / Custom cut	- 8
Lavabi d'appoggio / Sit on top basins	- 10
Lavabi Movado / Movado basins	- 12
Cover, Celeste e Diva Lavabi / Basins	- 14
Set-Up Lavabi / Basins	- 16
Pink Lavabi / Basins	- 18
Cover sanitari / Sanitary ware	- 20
Plus sanitari / Sanitary ware	- 22
Materiale promozionale / Promotional material	- 24
Condizioni generali di vendita / General sale terms	- 26



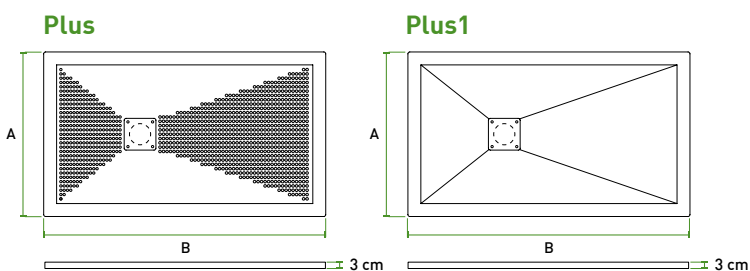

Profondità cm 70 / Width cm 70

Plus cod.	Plus1 cod.	A cm	B cm	€
PP79	PP179	70	90	442,00
PP710	PP1710	70	100	492,00
PP711	PP1711	70	110	540,00
PP712	PP1712	70	120	590,00
PP714	PP1714	70	140	688,00
PP716	PP1716	70	160	788,00
PP717	PP1717	70	170	838,00

Angolari / Corner

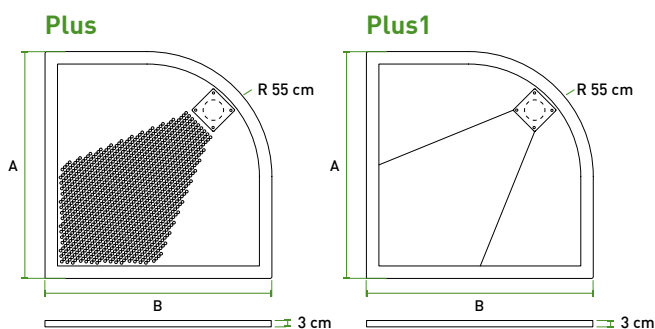

Profondità cm 80 / Width cm 80

Plus cod.	Plus1 cod.	A cm	B cm	€
PP88	PP188	80	80	450,00
PP89	PP189	80	90	506,00
PP810	PP1810	80	100	564,00
PP811	PP1811	80	110	620,00
PP812	PP1812	80	120	674,00
PP814	PP1814	80	140	788,00
PP816	PP1816	80	160	898,00
PP817	PP1817	80	170	954,00
PP819	PP1819	80	190	1.070,00

Plus cod.	Plus1 cod.	A cm	B cm	€
PP8A	PP18A	80	80	450,00
PP9A	PP19A	90	90	570,00
PP10A	PP110A	100	100	704,00

Profondità cm 90 e 100 / Width cm 90 and 100

Plus cod.	Plus1 cod.	A cm	B cm	€
PP99	PP199	90	90	570,00
PP910	PP1910	90	100	634,00
PP912	PP1912	90	120	758,00
PP914	PP1914	90	140	886,00
PP917	PP1917	90	170	1.076,00
PP1010	PP11010	100	100	704,00



Scarico sifonato ed ispezionabile GEBERIT
 GEBERIT shower tray drain
 (dip tube and trap insert can be dismantled)
 cod. 41699 € 50,00



Tutti i piatti doccia Plus sono da intendersi inclusi di copripiletta Plus+ton®.
 All the Plus trays include the Plus+ton® waste cover.

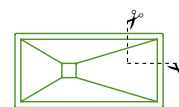

Taglio su misura
 Custom cut
 a partire da / starting from
 € 60,00

1. Scegli il modello del tuo piatto doccia Plus. / Choose the model of your Plus shower tray.

Plus

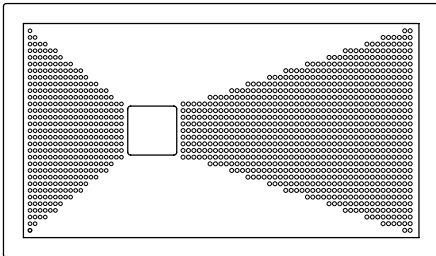

Plus1

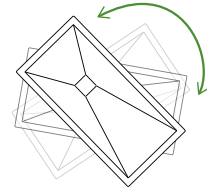
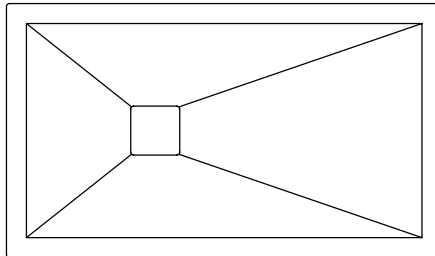

Reversible
Reversible

2. Individua la tipologia di taglio su misura. / Pick the kind of custom cut.

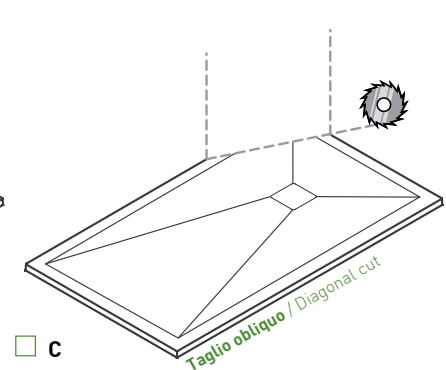
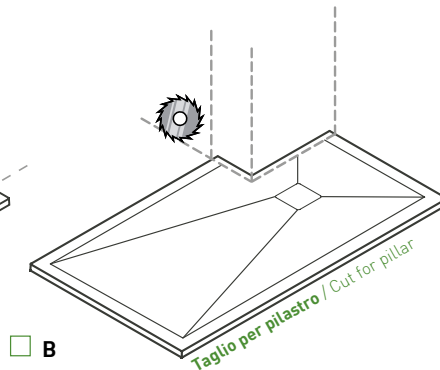
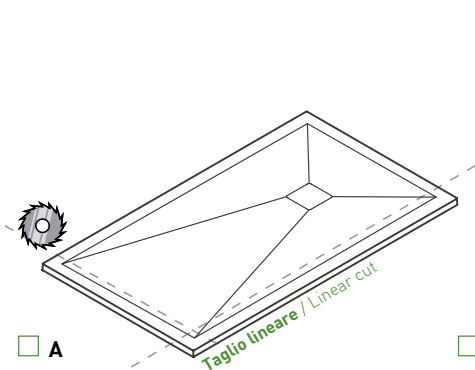

3. Alcuni esempi di taglio su misura. Quale taglio si avvicina alle tue esigenze? / Some examples of customized cuts. Which cut is the nearest to your needs?

/ Some examples of customized cuts. Which cut is the nearest to your needs?

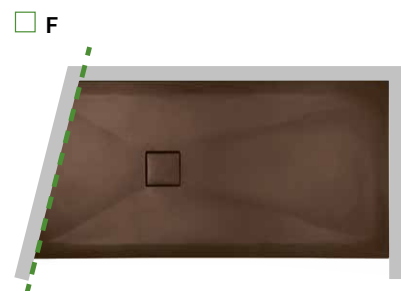
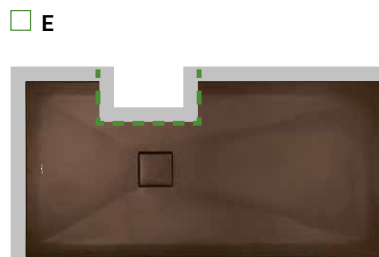
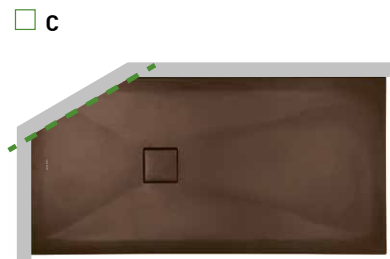
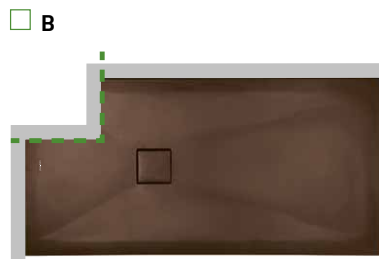
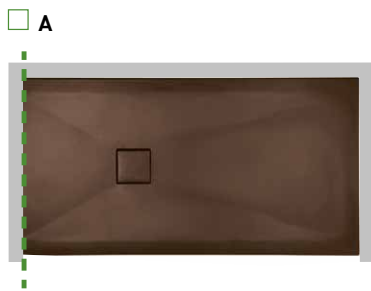

4. Utilizza lo schema sottostante per disegnare le linee di taglio, indicando le relative misure.
 / Use the below chart to draw the cutting lines, indicating the corresponding measures.

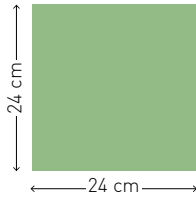

Lo spazio, evidenziato con il riquadro verde, non può subire operazioni di taglio.
 The space, highlighted with the green frame, cannot undergo cutting operations.

Scala 1:10
 Scale 1:10

N.B. Le parti del piatto doccia interessate dal taglio devono sempre aderire alle pareti e/o ai pilastri.

Per qualsiasi altro utilizzo l'azienda non si assume responsabilità.

N.B. The shower tray parts to be cut must always adhere to the walls and/or pillars.

The company will not accept responsibility for any other use.

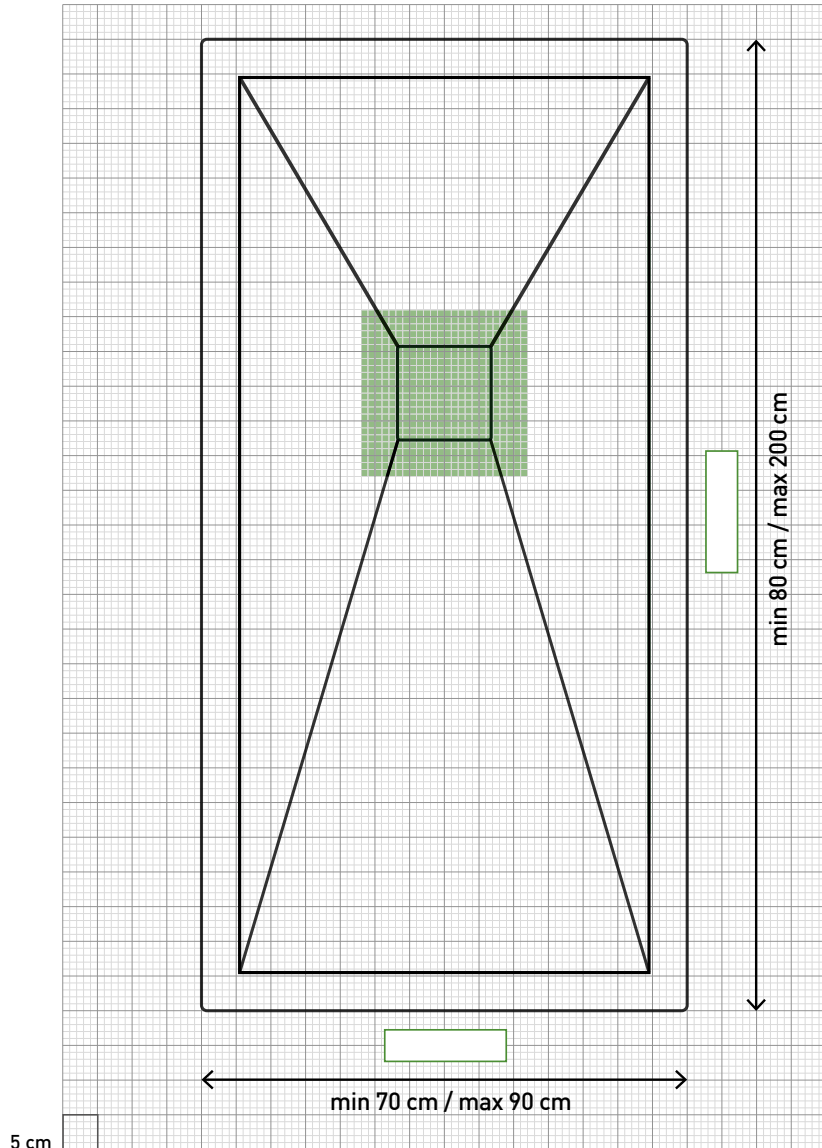

Riepilogo / Summary

Cliente / Customer:

Misura / Size:

Colore / Colour:



Codice / Code:



E' garantito un taglio perfetto / A perfect cut is guaranteed.

Basterà disegnare sullo schema le linee di taglio, indicando le relative misure.

Just draw the cutting outline on the layout and indicate the relative measures.

Data e firma per approvazione / Date and signature for approval



Cover 45
cm 45x35 H15



Lavabo / basin
cod. PCV45A € 440,00

Lavabo con troppopieno
Basin with overflow
cod. PCVT45A € 440,00

Cover 58
cm 58x35 H14



Lavabo / basin
cod. PCV58A € 480,00

Cover 70
cm 70x35 H15



Lavabo / basin
cod. PCV70A € 600,00

Cover 90
cm 90x35 H15



Lavabo / basin
cod. PCV90A € 760,00

Pons
cm 62x44 H12



Lavabo / basin
cod. PPNS € 464,00

Kassel
cm 43x43 H15



Lavabo / basin
cod. PKAS € 440,00

Kuadro
cm 40x40 H15



Lavabo / basin
cod. PKU € 520,00

Kuadro+
cm 40x40 H35



Lavabo / basin
cod. PKU+ € 840,00

Up
cm 55x40 H15



Lavabo / basin
cod. PUP € 544,00

Up+
cm 55x40 H35



Lavabo / basin
cod. PUP+ € 880,00







Movado45

cm 45x35 H3

Movado 45 con troppopieno / with overflow
cod. PMV45T € 480,00

Movado 45 senza troppopieno / without overflow
cod. PMV45 € 480,00



Movado58

cm 58x35 H3

Movado 58 con troppopieno / with overflow
cod. PMV58T € 520,00

Movado 58 senza troppopieno / without overflow
cod. PMV58 € 520,00



Cover80 Sx
cm 80x46



Cover80 Dx
cm 80x46



Celeste110
cm 110x46



Celeste80
cm 80x46



Celeste60
cm 60x46



Diva H18
cm 65x46



Diva H14
cm 65x46



Diva slim
cm 65x43
Incasso
Built-in



Cover cod.	Dimensione Size cm	€
PCV80S	80x46 Sx	480,00
PCV80D	80x46 Dx	480,00

Celeste cod.	Dimensione Size cm	€
PCL110	110x46	600,00
PCL80	80x46	448,00
PCL60	60x46	320,00

Diva cod.	Dimensione Size cm	€
PDV18	65x46 H18	560,00
PDV14	65x46 H14	496,00
PDVI	65x43 slim	496,00







Set-up₄₁
cm 41x37



Set-up₅₁
cm 51x37

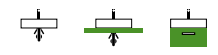

Set-up₆₁
cm 61x37



Set-up₇₁
cm 71x37



Set-up₈₁
cm 81x37

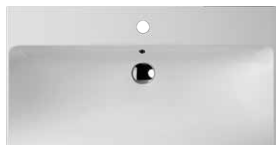

Set-up₈₆
cm 86x37

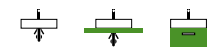

Set-up₉₁
cm 91x37

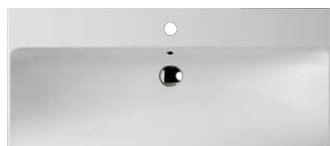
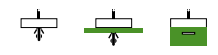

Set-up₉₆
cm 96x37

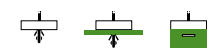

Set-up₁₀₆
cm 106x37



Set-up_{106dx}
cm 106x37



Set-up_{106sx}
cm 106x37



Set-up_{121dx}
cm 121x37



Set-up_{121sx}
cm 121x37



Set-up cod.	Dimensione Size cm	€
PSU41	41x37	360,00
PSU51	51x37	384,00
PSU61	61x37	416,00
PSU71	71x37	464,00
PSU81	81x37	520,00
PSU86	86x37	544,00
PSU91	91x37	568,00
PSU96	96x37	600,00
PSU106	106x37	680,00
PSU106D	106x37dx	816,00
PSU106S	106x37sx	816,00
PSU121D	121x37dx	896,00
PSU121S	121x37sx	896,00



Pink

Pink61
cm 61x46



Pink71
cm 71x46



Pink81
cm 81x46



Pink86
cm 86x46



Pink91
cm 91x46



Pink96
cm 96x46



Pink101
cm 101x46



Pink106
cm 106x46



Pink121
cm 121x46



Pink121 db
cm 121x46

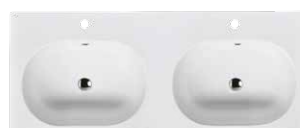

Pink141 db
cm 141x46



Pink cod.	Dimensione Size cm	€
PPK61	61x46	320,00
PPK71	71x46	368,00
PPK81	81x46	416,00
PPK86	86x46	448,00
PPK91	91x46	472,00
PPK96	96x46	496,00
PPK101	101x46	544,00
PPK106	106x46	568,00
PPK121	121x46	720,00
PPK121DB	121x46db	840,00
PPK141DB	141x46db	1.000,00







Cover

Wc
cm 52x36



Wc
cod. PCV1 € 450,00
Copri Wc SLIM SOFT-CLOSE
cod. PCV8S € 240,00

Wc sospeso
Wall hung wc
cm 52x36



Wc sospeso
cod. PCV3 € 450,00
Copri Wc SLIM SOFT-CLOSE
cod. PCV8S € 240,00

Wc + Totem
cm 66x40



Wc
cod. PCV1 € 450,00
Copri Wc SLIM SOFT-CLOSE
cod. PCV8S € 240,00
Totem
cod. PCV7 € 536,00

Wc monoblocco
Close-coupled wc
COMPACT
cm 60x36



Wc monoblocco
cod. PCV5 € 584,00
Copri Wc SLIM SOFT-CLOSE
cod. PCV8S € 240,00
Cassetta monoblocco
cod. PCV6 € 380,00

Bidet
cm 52x36



Bidet
cod. PCV2 € 450,00



Bidet sospeso
Wall hung bidet
cm 52x36



Bidet sospeso
cod. PCV4 € 450,00



Cover56
Bidet
cm 56x36
cod. PCV562



Bidet56
cod. PCV562 € 624,00



Installazione
regolabile
Adjustable
installation

Cover56
Wc
cm 56x36
Wc cod. PCV561
Seat cover cod. PCV8



Wc56
cod. PCV561 € 624,00
Copri Wc SLIM SOFT-CLOSE
cod. PCV8S € 240,00



Scarico
traslato
Adjustable
flush system

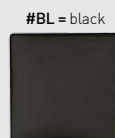





Wc sospeso
Wall hung wc
cm 48x37



Wc
cod. PPL3 **€ 420,00**
Copri Wc SOFT-CLOSE
cod. PPL8 **€ 240,00**

Bidet sospeso
Wall hung bidet
cm 48x37



Bidet
cod. PPL4 **€ 420,00**



Campionario colori

Colour presenter

cod. camppl € 70,00



Espositore in legno piatto doccia Plus

Wooden display for Plus shower tray

cod. espositore2 € 600,00

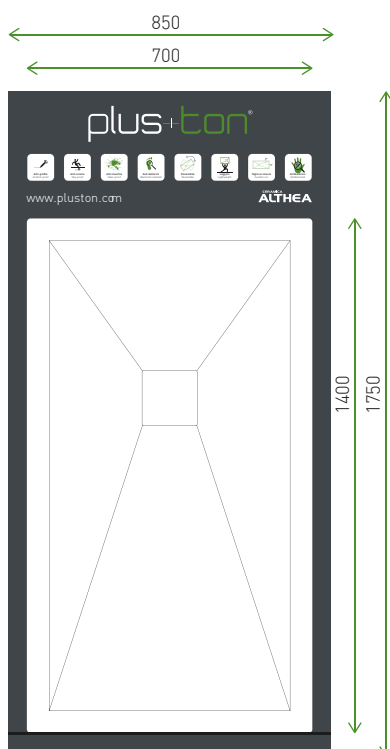

Espositore piatto doccia Plus

Plus shower tray display

cod. espositore € 1.300,00

- **Schermo Led con proiezione continua di contenuti digitali**
Led screen with continuous projections of digital contents
- **Design funzionale**
Functional design
- **Struttura pieghevole**
Folding structure
- **Ruote per facilitare gli spostamenti**
Wheels to make it easy to move
- **Sistema di fissaggio rapido del piatto doccia Plus**
Quick anchorage system for the Plus shower tray
- **Memoria USB**
USB memory

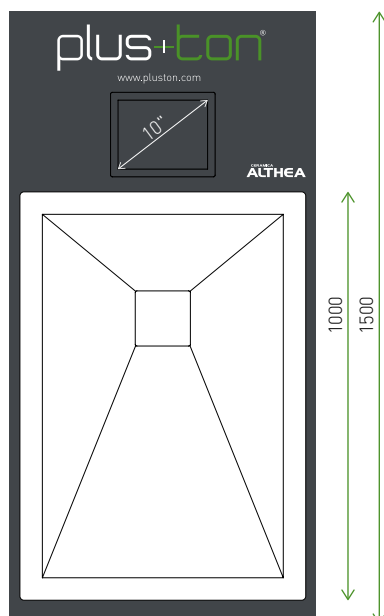

Condizioni di vendita

CONDIZIONI GENERALI DI VENDITA

ORDINAZIONI:

dovranno essere passate alla società e dalla stessa confermate, sia per i prezzi sia per il termine di consegna. La merce è venduta franco fabbrica e viaggia, in ogni caso, a rischio e pericolo del committente.

TRASPORTO:

rimane sempre a carico del committente per conto del quale la società esegue la spedizione.

IMBALLO:

effettuato su pallets verrà addebitato il costo del 3% della fornitura.

PREZZI:

la società si riserva la facoltà di variare i prezzi senza alcun preavviso. In ogni caso i prezzi validi saranno quelli del listino in vigore al momento della consegna. Tutti i prezzi si intendono esclusi IVA.

PAGAMENTI:

i pagamenti debbono essere effettuati, esclusivamente, presso la sede della società fornitrice, salvo patto contrario espresso. Il mancato pagamento di una eventuale precedente fornitura autorizza la Società Ceramica Althea Spa a sospendere le forniture e ad annullare eventuali ordini in portafoglio.

In caso di contestazione di qualsiasi natura il committente non ha diritto di sospendere i pagamenti.

CONSEGNA:

i termini di consegna sono puramente indicativi. In ordine a tali termini, pertanto, la Società fornitrice non potrà assumere responsabilità di qualsiasi genere, salvo i casi di pattuizione esplicita.

PESI E MISURE:

entrambi sono approssimativi e pertanto la Società fornitrice non potrà assumere alcun tipo di responsabilità per gli stessi.

RECLAMI:

dovranno pervenire alla ns. Sede non oltre otto giorni dal ricevimento della merce. In ogni caso non si accettano merci di ritorno, senza che sia intercorso un accordo in tal senso con la fornitrice.

RISERVA DI PROPRIETÀ':

fino a che il pagamento non sia stato completato la merce rimane di proprietà della fornitrice.

DATI RIGUARDANTI IL COMMITTENTE:

il committente è responsabile di tutti i dati identificativi, in particolare, per quanto si riferisce alle norme relative all'anagrafe tributaria (Codice Fiscale).

DOMICILIO LEGALE:

per qualsiasi controversia, competente è il Foro di Viterbo (Italia).

INTERESSI MORATORI:

qualora si verificassero ritardi dei pagamenti verranno addebitati gli interessi al tasso praticato dagli Istituti di Credito all'atto dell'addebito.

DIMENSIONI:

Le misure di ciascun lavabo sono da considerarsi identificative e suscettibili di variazioni a causa delle caratteristiche peculiari della lavorazione ceramica.

Ceramica Althea Spa si riserva il diritto di apportare, in qualsiasi momento, modifiche tecniche, costruttive e dimensionali utili al miglioramento della produzione.

Le tonalità degli smalti possono subire lievi variazioni da considerarsi in tolleranza a causa delle caratteristiche peculiari della lavorazione ceramica.

L'azienda si riserva il diritto di apportare modifiche o rimuovere dalla produzione gli articoli presenti in questo catalogo senza preavviso.

GENERAL SALE TERMS

ORDERS:

must be placed with the firm that will confirm both prices and delivery terms. Goods are sold on an ex-factory basis and transport is carried out at the customer's own risk.

TRANSPORT:

is always to be paid by the customer on whose behalf the firm may ship the goods.

PACKAGING :

on pallets, 3% of the consignment value will be debited.

PRICES:

the firm reserves the right to vary prices without any previous notice. In any case, the prices to be considered valid are those contained in the price-list in force at the time of delivery.

Prices do not include V.A.T.

PAYMENT:

must be made exclusively to the supplying firm unless otherwise agreed upon. Failure to pay a previous supply allows the firm Ceramica Althea Spa to stop shipping goods and cancel any pending order. In case of any claims, the customer must not suspend payment.

DELIVERY:

dates are merely approximate. Consequently the supplying firm bears no responsibility for delivery dates, unless otherwise agreed upon.

WEIGHT AND SIZES:

these are approximate and therefore the firm bears no responsibility for them.

CLAIMS:

must be submitted to our head office within 8 days upon receipt of the goods. Returned goods are not accepted unless otherwise agreed upon with the manufacturer.

RIGHTS OF OWNERSHIP:

until payment is fully settled, the goods remain the property of the supplying firm.

CUSTOMER DETAILS:

the customer is responsible for all identification details provided, particularly for those referring to the tax register office (tax code).

LEGAL RESIDENCE:

for any controversy the competent court is the Court of Viterbo (Italy).

INTEREST ON DELAYED PAYMENTS:

should there be delay in payments, interest will be charged at the rate fixed by credit institutions at the moment of debiting.

DIMENSIONS

The measures of each basin are to be considered as approximate and susceptible to variations because of the specific characteristics of the ceramic workmanship.

CONDICIONES GENERALES DE VENTA

PEDIDOS:

tendrán que pasarse a la empresa y ser confirmados por la misma tanto por lo que se refiere a los precios como a los plazos de entrega. Los productos se venden ex works y viajan, en cualquier caso, a riesgo y responsabilidad del cliente.

TRANSPORTE:

siempre es a cargo del cliente.

EMBALAJE:

realizado en palets, se cobrará el 3% del coste total del suministro.

PRECIOS:

la empresa se reserva el derecho de modificar los precios sin previo aviso. En cualquier caso, los precios válidos serán los de la lista de precios en vigor en el momento de la entrega. Todos los precios no incluyen IVA.

PAGOS:

los pagos deben efectuarse exclusivamente en la sede del proveedor, salvo que se acuerde lo contrario. La falta de pago de cualquier entrega anterior autoriza a Ceramica Althea Spa a suspender los suministros y a cancelar cualquier pedido pendiente. En caso de incidencia de cualquier género el cliente no tiene derecho a suspender los pagos.

ENTREGA:

los plazos de entrega sólo son indicativos. En conformidad con estos términos, por lo tanto, la empresa proveedora no podrá asumir responsabilidades de ningún tipo, salvo en caso de estipulación expresa.

PESOS Y MEDIDAS:

ambos son aproximados y, por lo tanto, la empresa proveedora no asumirá ninguna responsabilidad por los mismos.

RECLAMACIONES:

tendrán que llegar a nuestra empresa dentro de los ocho días siguientes a la recepción de la mercancía. En cualquier caso, no aceptamos mercancías de vuelta, sin que haya un acuerdo a tal efecto con el proveedor.

RESERVA DE PROPIEDAD:

hasta que el pago no esté finalizado los bienes son propiedad del proveedor.

DATOS RELATIVOS AL COMPRADOR:

el comprador es responsable de todos los datos de identificación, en particular en lo que se refiere a las normas sobre su impuesto (Código Tributario).

DOMICILIO LEGAL:

por cualquier litigio, la jurisdicción es el Tribunal de Viterbo (Italia).

INTERESES MORATORIOS:

en caso de retrasos en los pagos se cobrarán los intereses según la tasa aplicada por los Institutos Bancarios al momento del adeudo.

DIMENSIONES:

Las medidas de cada lavabo deben considerarse aproximadas y sujetas a variaciones debido a las características peculiares del proceso cerámico.

Ceramica Althea Spa se reserva el derecho de aportar, en cualquier momento, cambios técnicos, constructivos y de medidas para mejorar la producción.

Las tonalidades de los esmaltes pueden sufrir leves variaciones que deben considerarse dentro de la tolerancia por las características peculiares de la producción cerámica.

ALLGEMEINE VERKAUFSBEDINGUNGEN

BESTELLUNGEN:

diese müssen im Unternehmen eingegangen sein und von innen bestätigt worden sein, sowohl in Bezug auf die Preise, als auch auf die Lieferzeiten. Die Ware wird frei Fabrik verkauft und reist in jedem Fall auf Risiko und Gefahr des Auftraggebers.

TRANSPORT:

immer zu Lasten des Auftraggebers, für den das Unternehmen die Spedition ausführt.

VERPACKUNG:

ausgeführt auf Paletten werden Kosten in Höhe von 3% der Lieferung auferlegt.

PREISE:

das Unternehmen behält sich die Befugnis vor, die Preise ohne jede Vorankündigung abzuändern. In jedem Fall werden die Preise der Preisliste angerechnet, die im Moment der Warenübergabe gültig ist. Alle Preise verstehen sich ausschliesslich MWST.

BEZAHLUNG:

die Bezahlungen dürfen ausschliesslich im Sitz der Lieferfirma ausgeführt werden, soweit nicht anders vereinbart. Das Ausbleiben der Zahlung einer eventuell vorhergehenden Lieferung autorisiert das Unternehmen Ceramica Althea Spa dazu, die Lieferung aufzuheben und eventuell anstehende Bestellungen zu annullieren. Bei Streitigkeiten jeglicher Natur hat der Auftraggeber nicht das Recht, die Zahlungen aufzuheben.

LIEFERUNG:

die Lieferbedingungen sind rein indikativ. In Bezug auf diese Bedingungen kann deshalb die Lieferfirma keinerlei Verantwortung übernehmen, soweit nicht anders vereinbart worden ist.

GEWICHTE UND MASSE:

beide sind annähernd. Man übernimmt keinerlei Verantwortung über diese, da die Angaben in der beigelegten Preisliste nur indikativen Charakter haben.

BESCHWERDEN:

diese müssen in unserem Firmensitz binnen acht Tagen ab Erhalt der Ware eingehen. In keinem Fall werden Warenrücksendungen akzeptiert, ohne dass mit der Lieferfirma vorher eine Vereinbarung in diesem Sinne getroffen worden ist.

EIGENTUMSVORBEHALT:

bis zur vollständigen Bezahlung bleibt die Ware Eigentum der Lieferfirma.

DATEN ÜBER DEN AUFTRAGGEBER:

der Auftraggeber ist Verantwortlich für alle angegebenen Daten, insbesondere für diejenigen, die sich auf fiskalische Angaben beziehen (Steuernummer).

GESETZLICHER WOHNSITZ:

für jegliche Streitigkeiten ist das Amtsgericht in Viterbo (Italien) zuständig.

VERZUGSZINSEN:

falls bei der Bezahlung Verspätungen eintreten, werden Zinsen in Höhe von dem Zinssatz

plus-ton®

360°

Price list 2019/20

© Copyright Ceramica Althea SpA - Settembre 2019

CERAMICA
ALTHEA

Viale delle Industrie, 9
01033 - Civita Castellana (VT) - Italy
tel. + 39 0761542144 / fax + 39 0761542129
info@altheaceramica.it

www.pluston.com



100 % Made in Italy